

AYARLI KAPI KASASI PROFİLLERİ

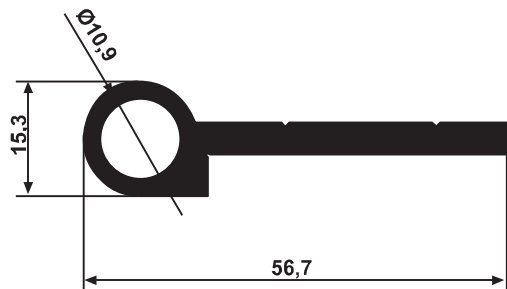

AYARLI KAPI KASASI PROFİLLERİ

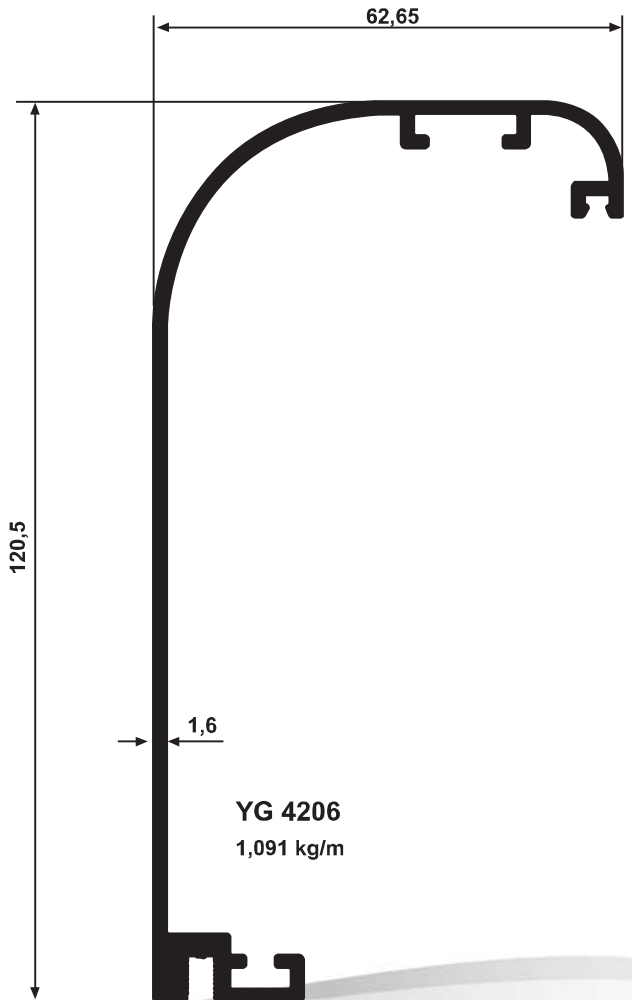
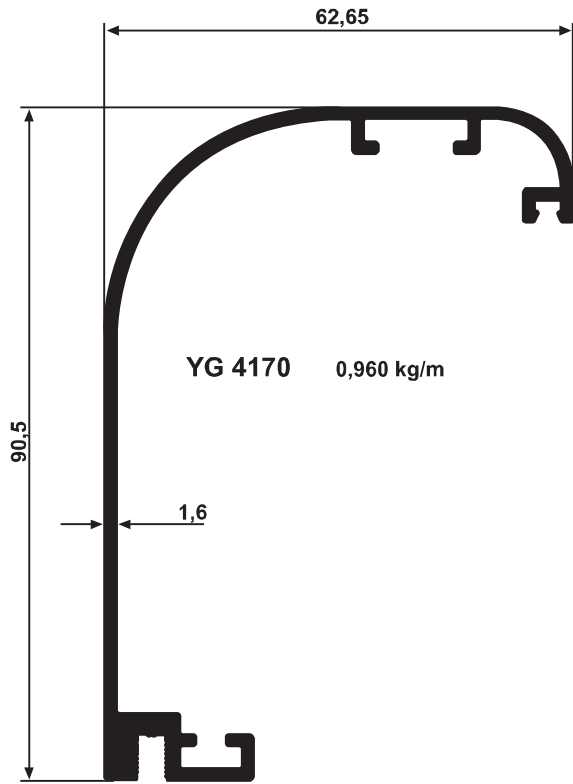
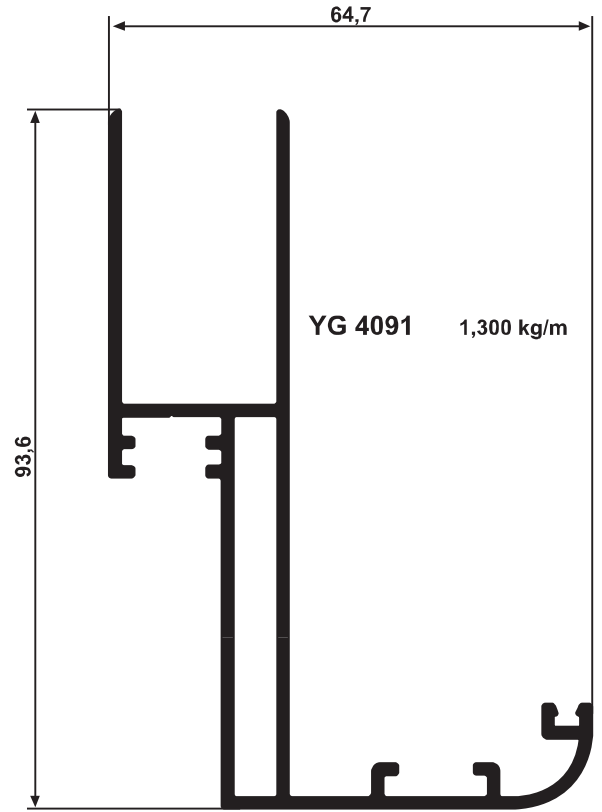
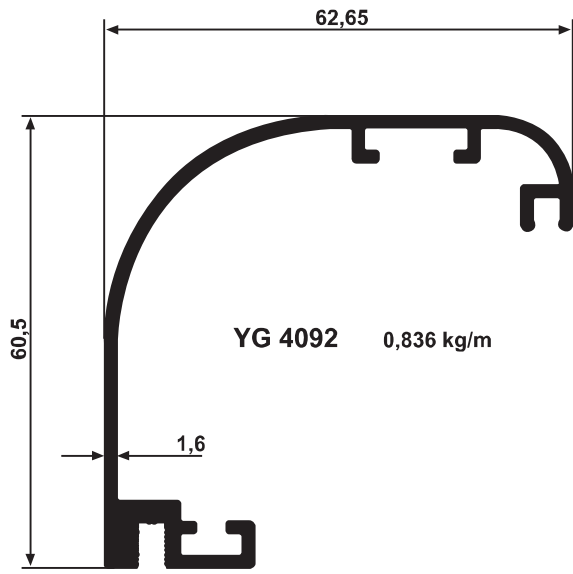
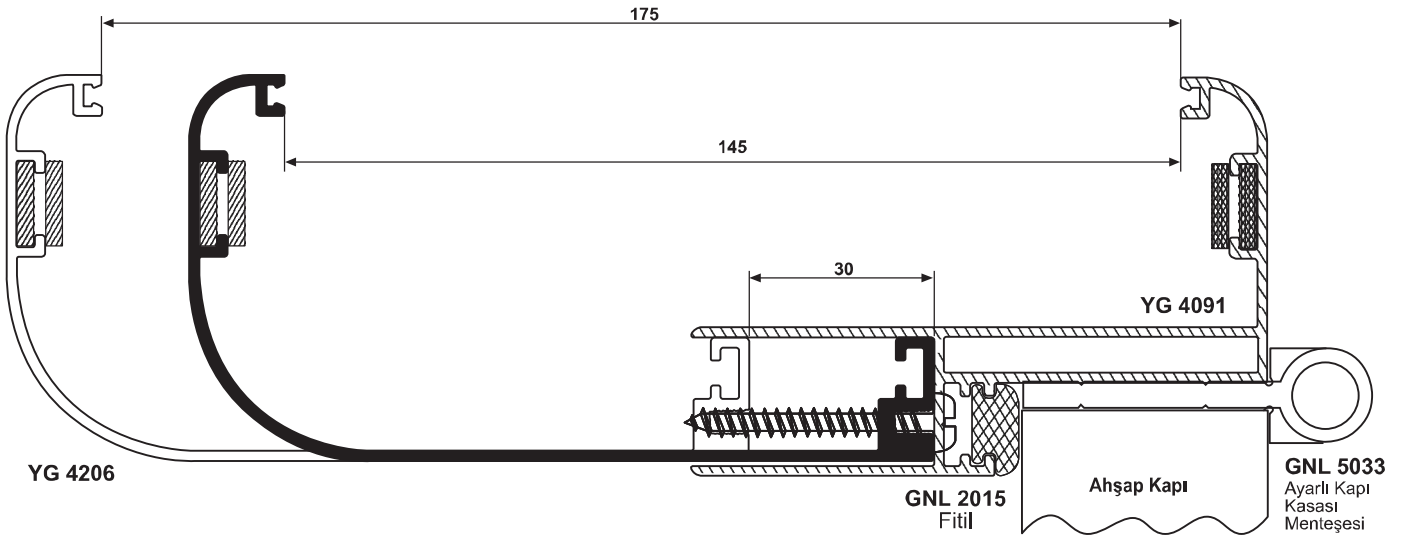
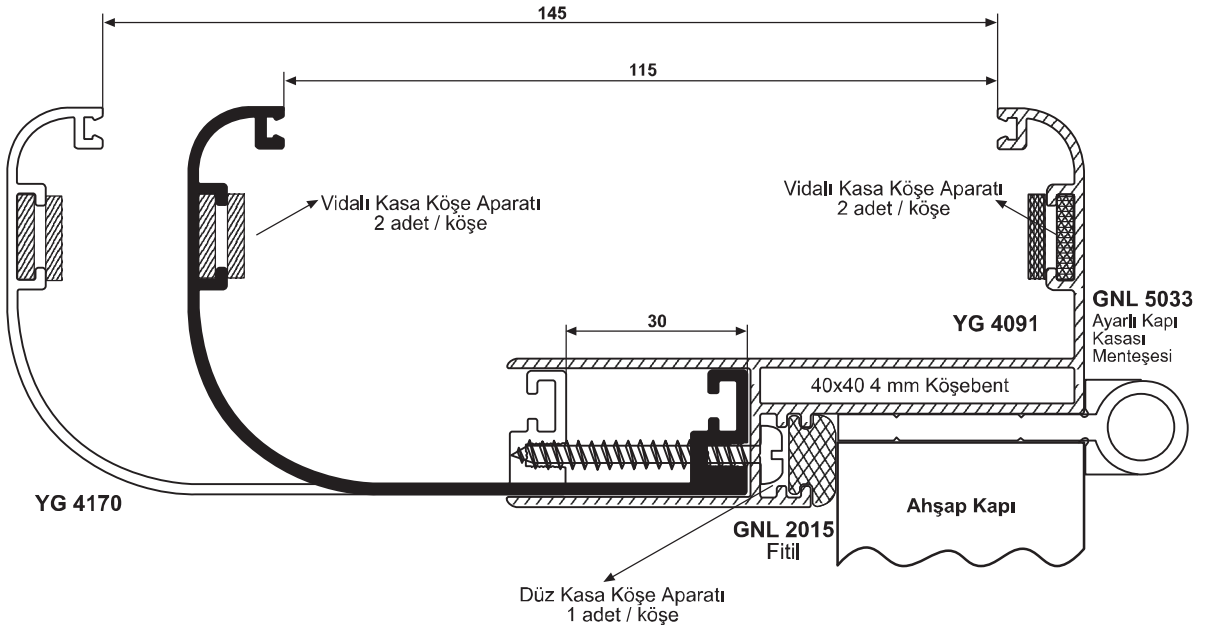
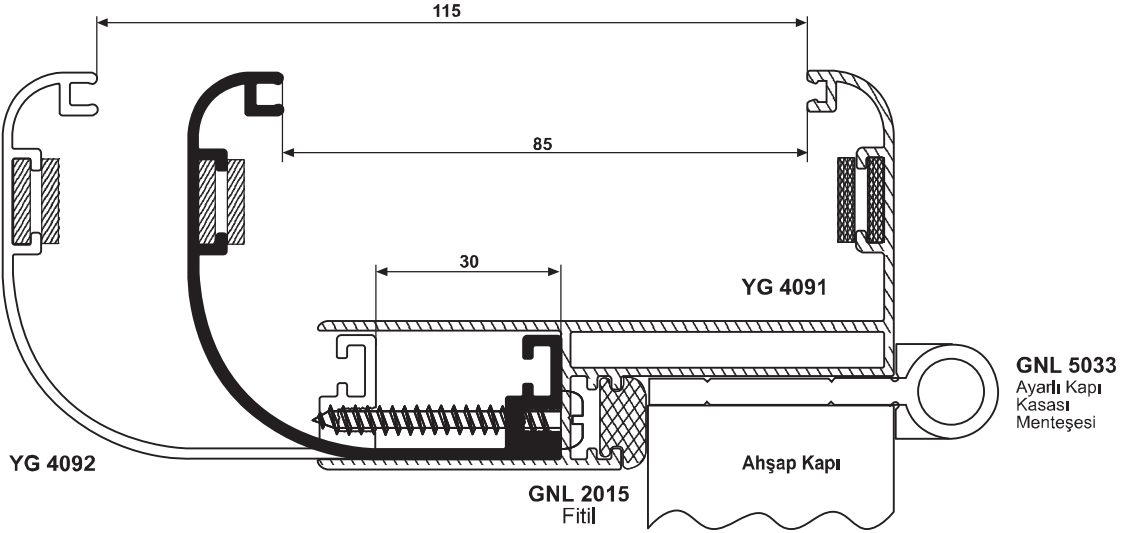

AYARLI KAPI KASASI PROFİLLERİ

YG 4206



GNL 2015 Fitol

GNL 5032 Kasa Köşe Aparatı

- Vidalı
- Düz
- Delikli

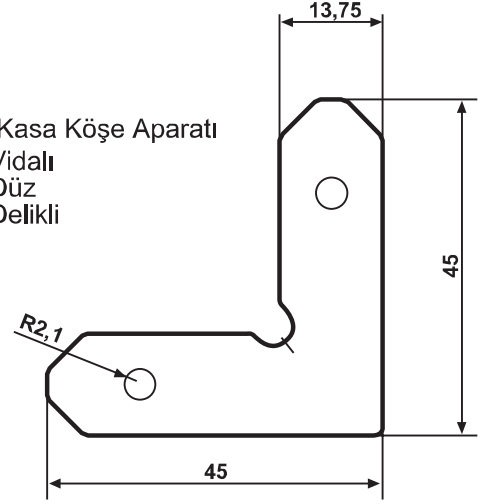

ARA AÇIKLIK (mm)

	YG 4092	YG 4170	YG 4206
KUTU OLMASIZIN	85 - 115	115 - 145	145 - 175
20x20 KUTU ile	105 - 135	135 - 165	165 - 195
20x40 KUTU ile	125 - 155	155 - 185	185 - 215
20x50 KUTU ile	135 - 165	165 - 195	195 - 225
20x60 KUTU ile	145 - 175	175 - 205	205 - 235
20x80 KUTU ile	165 - 195	195 - 225	225 - 255
20x100 KUTU ile	185 - 215	215 - 245	245 - 275

Bir ayarlı kapı kasasında kullanılan aksesuar

- 4 adet GNL 5032 Vidalı Kasa Köşe Aparatı
- 2 adet GNL 5032 Düz Kasa Köşe Aparatı
- 2 adet GNL 5032 Delikli Kasa Köşe Aparatı
- 3 adet GNL 5033 Ahşap Kapı Mentşesi
- Kasa ölçüsünce GNL 2015 Fitol

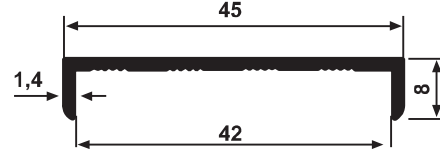

YG 4246 0,210 kg/m
Ahşap Kapı Yan Bant

GNL 2015 Fitol

YG 4091

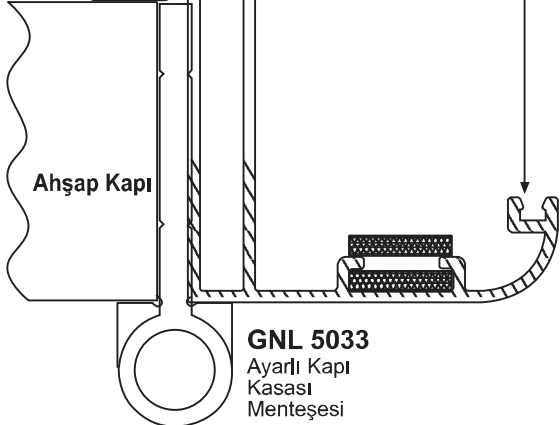

Ahşap Kapı İçine Cam Uygulaması

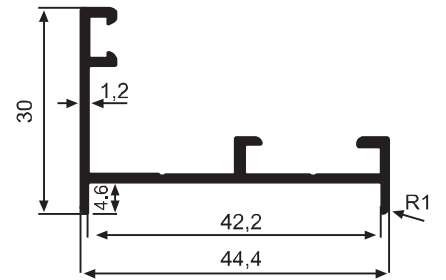
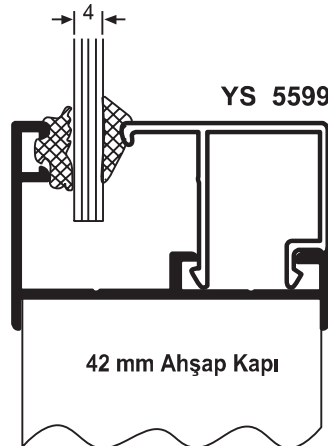

D-YG 1058 0,340 kg/m

AYARLI KAPI KASASI PROFİLLERİ

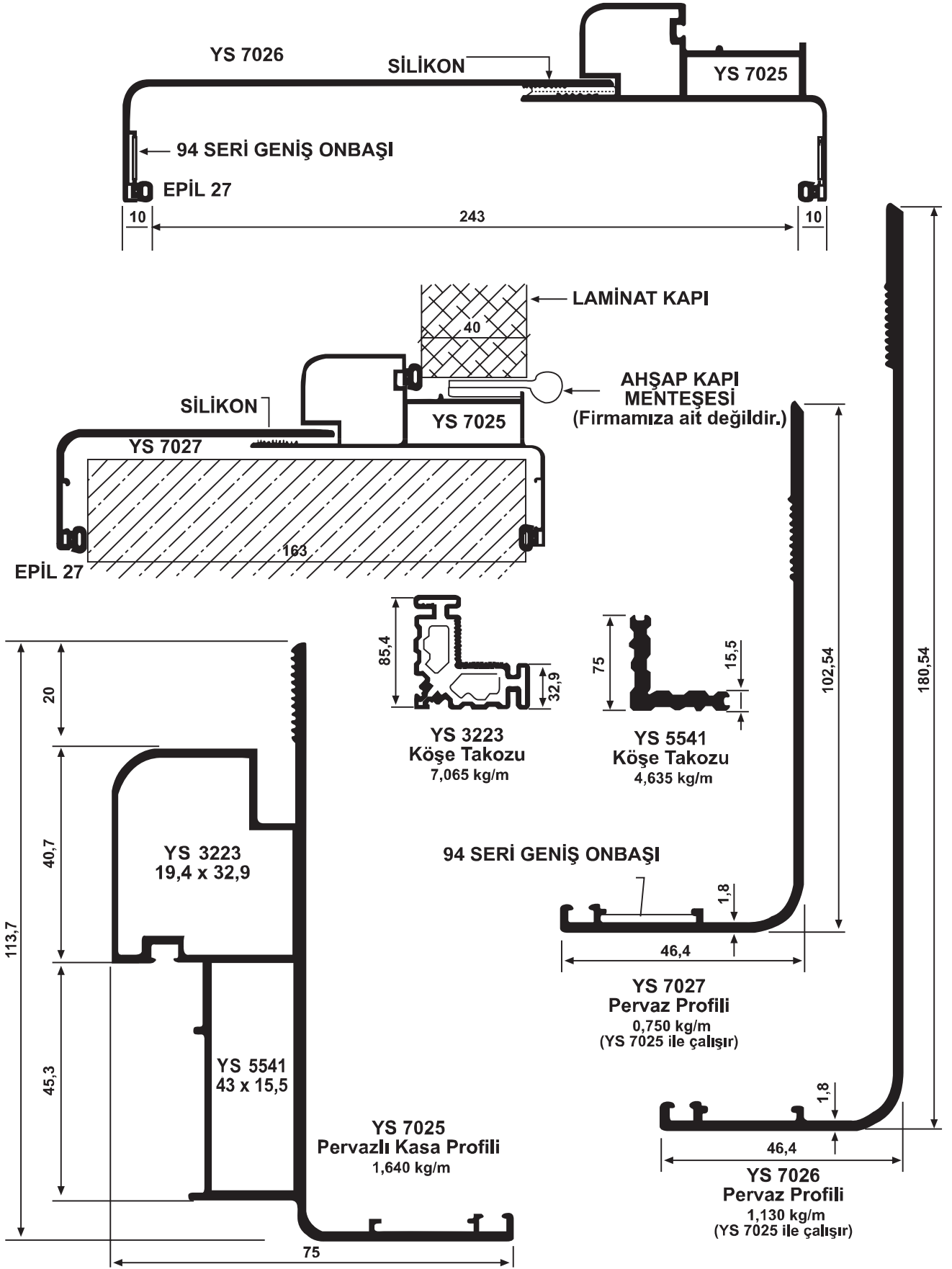

AYARLI KAPI KASASI PROFİLLERİ

